

**Model: MPCX-9800**  
**Fanless Mini Box PC - support Intel Core i3/5/7 Mobile Processor**



**Back View**



**Front View**

**Features**

- Fanless design with compact size
- Support Intel Intel Core™ i3, i5, i7 Mobile Processors
- Intel QM57 chipset
- 2 x SO-DIMM DDRIII 800/1066 Slot, Max to 8GB
- 1 x 2.5-inch anti-vibration HDD and 1x Mini PCI-E socket
- Multiple I/O, USB2.0, GbE, COM, VGA, DVI, HDMI, Mini PCI-E, HD Audio
- DC 12V input ( Wide range DC 8-30V input option )

**Specifications**

**System Characteristics**

Processor	: Support Intel Core i3/5/7 Mobile Processor, socket G(rPGA998a) Side Bus 1066MHz
Chipset	: Intel QM57
Memory	: 2 x SO-DIMM DDRIII 800/1066 Slot, Max to 8GB
Storage	: 1 x 2.5" SATA HDD ,anti-vibration
Graphic	: VGA, DVI-D, HDMI
Ethernet	: 1 x 10/100/1000Mbps
VGA	: 1 x VGA connector
DVI	: 1 x DVI connector
HDMI	: 1 x HDMI connector
Audio	: VIA VT 1705 6-Channel HD Audio
USB	: 6 x USB 2.0
Serial	: 1 x RS-232
Expansion Slot	: 1x Mini PCI-E ( internal )
WLAN	: IEEE 802.11b/g ( option )

**I/O connector**

**Front I/O Panel**

- 1 x Power Switch Button
- 1 x Reset Switch Button
- 1 x HDD Active LED
- 1 x Power LED
- 2 x USB 2.0

**Rear I/O panel**

- 1 x 10/100/1000 LAN port ( RJ45 )
- 1 x VGA
- 1 x DVI
- 1 x HDMI
- 6 x USB
- 1 x RS-232
- 1 x Main power ON/OFF Switch
- 1 x Lockable DC Input connector
- 1x Line in / Line out / MIC in

## Mechanical Specification

Construction : Rugged Aluminum extrusion + steel housing  
 Mounting : Desktop / Wall mounting  
 Weight : Net: 5.5 kg, Gross: 7.5 kg  
 Dimension : 257 x 195 x 88.8 mm (W x D x H)

## Environmental Specification

Operation Temperature : 0 -50 C  
 Storage Temperature : -20 – 60 C  
 Humidity : 10%-90% non-condensing  
 Vibration : 1grms ( 5-500Hz / 3-axes )  
 Shock : 10g/ 11ms

## Power Specifications

AC IN : 90- 240V, 50/60HZ  
 DC out : 12V/8A ,96Watts external AC Adapter with Lockable connector

## Certification and Approvals

-CE/FCC/ROHS

## Ordering Information

MPCX-9800 : Fanless Mini Box PC support Intel Core i3/5/7 Mobile Processor  
 MP-2501 : Mini PCI wireless LAN card with antenna

## Design Drawings

Unit : mm

TOP VIEW

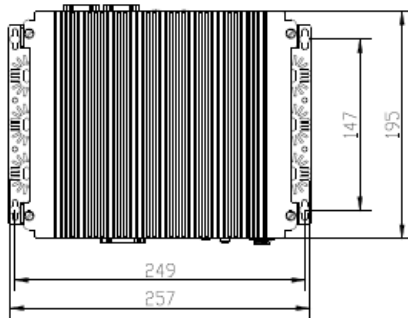

LEFT VIEW

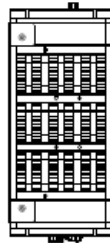

RIGHT VIEW

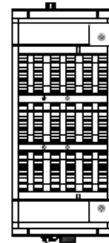

BOTTOM VIEW

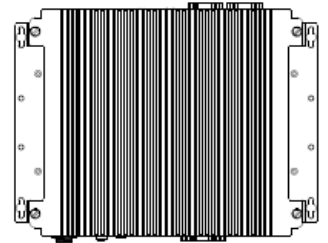

FRONT VIEW

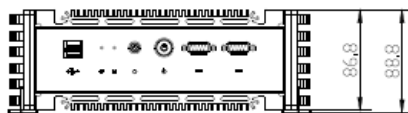

ISOMETRIC VIEW

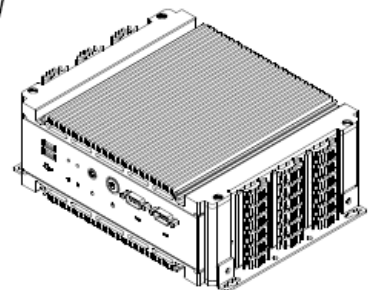
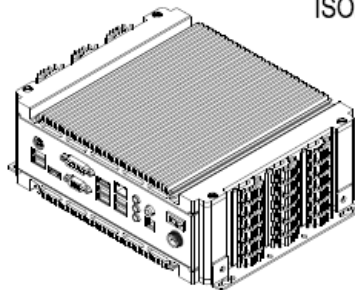

BACK VIEW

